



# Dynalite Sensors

## DUS90AHB-DALI

The Philips Dynalite sensor range combines motion detection, light level detection and IR receive in one unit. Each of these features can be operated at the same time, allowing automation scenarios such as turning on the lights after detecting motion and then dimming the lighting level once the available sunlight has been measured, thereby providing additional energy savings. By combining each of these functions into one device, operational efficiency is improved. Each sensor has an in-built microprocessor, allowing logical functions to control one small room, the floor of a building, or an entire building. All sensors receive their power from the DyNet network, and as they are fully remotely programmable, they can be configured to automate and control a virtually unlimited number of controlled outputs.

The Philips Dynalite sensor range combines motion detection, light level detection and IR receive in one unit. Each of these features can be operated at the same time, allowing automation scenarios such as turning on the lights after detecting motion and then dimming the lighting level once the available sunlight has been measured, thereby providing additional energy savings. By combining each of these functions into one device, operational efficiency is improved. Each sensor has an in-built microprocessor, allowing logical functions to control one small room, the floor of a building, or an entire building. All sensors receive their power from the DyNet network, and as they are fully remotely programmable, they can be configured to automate and control a virtually unlimited number of controlled outputs.

### Product data

## Dynalite Sensors

### General Information

CE mark	CE mark
Remarks	Please download the Lighting - Product Data Sheet for more information and ordering options
EU RoHS compliant	Yes

### Application Conditions

Ambient temperature range	-5 to +50 °C
---------------------------	--------------

### Product Data

Full product code	871869600510100
-------------------	-----------------

Order product name	DUS90AHB-DALI
EAN/UPC – product	8718696005101
Order code	00510100
SAP numerator – quantity per pack	1
Numerator – packs per outer box	1
SAP material	913703015409
SAP net weight (piece)	75.000 g

### Dimensional drawing

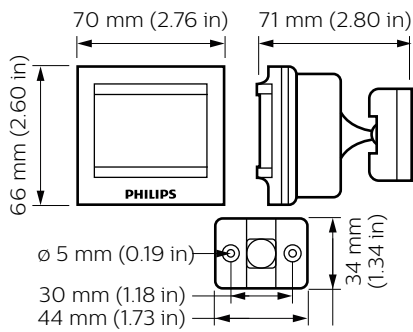

DUS90-AHB-DALI

