



Dynalite Leading Edge Dimmers

DLE1220GL

12 channel Leading Edge Dimmer Controller with a maximum load per channel of 20 A.

The Philips Dynalite DLE1220GL is a 12 channel leading edge dimmer controller, with a maximum load per channel of 20 A and total device load of 180 A. - It is suitable for use with incandescent, neon and selected fluorescent light sources, as well as iron core and leading edge dimmable electronic transformers. - Large load capability DMX512 compatibility Interference suppression Naturally ventilated Soft start and voltage regulation technologies Diagnostic functionality User controls Options available

Product data

General Information	
CE mark	CE mark
Remarks	Please download the Lighting - Product Data Sheet for more information and ordering options
EU RoHS compliant	Yes
Application Conditions	
Ambient temperature range	0 to +40 °C
Product Data	
Full product code	871016350572500

Order product name	DLE1220GL
EAN/UPC – product	8710163505725
Order code	50572500
SAP numerator – quantity per pack	1
Numerator – packs per outer box	1
SAP material	913703016009
SAP net weight (piece)	29.000 kg

Dynalite Leading Edge Dimmers

Dimensional drawing

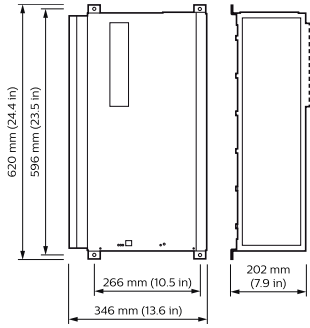

Dynalite Leading Edge Dimmers

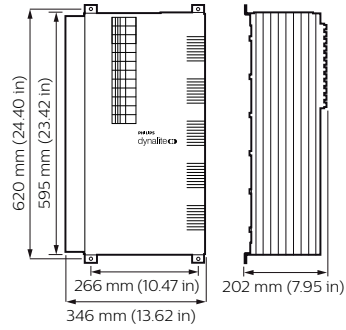

Dynalite Leading Edge Dimmers

