



Dynalite System Integration

DIR-TX8

DIR-TX8 Infrared Transmitter for cost-effective integration and control

DIR-TX8 Infrared Transmitter for cost-effective integration and control

Product data

General Information	
CE mark	CE mark
Remarks	Please download the Lighting - Product Data Sheet for more information and ordering options
EU RoHS compliant	Yes
Application Conditions	
Ambient temperature range	0 to +50 °C
Product Data	
Full product code	871016350772900

Order product name	DIR-TX8
EAN/UPC – product	8710163507729
Order code	50772900
SAP numerator – quantity per pack	1
Numerator – packs per outer box	1
SAP material	913703080009
SAP net weight (piece)	0.280 kg

Dynalite System Integration

Dimensional drawing

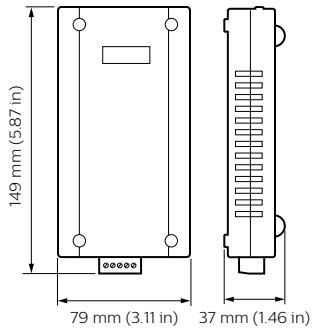

Dynalite System Integration

