



Dynalite Network Accessories

DTK622-232

Network gateway for passive integration to a PC or RS232 system. Also available as DTK622-USB (913703090209)

Network gateway for passive integration to a PC or RS232 system. Also available as DTK622-USB (913703090209)

Product data

General Information	
CE mark	CE mark
Remarks	Please download the Lighting - Product Data Sheet for more information and ordering options
EU RoHS compliant	Yes
Application Conditions	
Ambient temperature range	0 to +40 °C
Product Data	
Full product code	871016350802300

Order product name	DTK622-232
EAN/UPC – product	8710163508023
Order code	50802300
SAP numerator – quantity per pack	1
Numerator – packs per outer box	1
SAP material	913703090109
SAP net weight (piece)	0.230 kg

Dynalite Network Accessories

Dimensional drawing

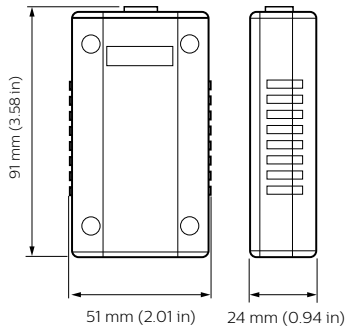

Dynalite Network Accessories

