



GreenPerform Highbay G3

BY698X LED200/CW PIR NB L3000 EN

865 cool daylight - Power supply unit regulating - Narrow beam

Following the successful introduction of the GreenPerform Highbay G2 in 2013, while continue providing the superior light quality, long service lifetime, reduced energy consumption and less maintenance in the switch on-off (PSU) and Dali dimmable (PSD) versions, the new generation Highbay seamlessly integrates state-of-the-art LED lighting with an easy-to-use and reliable wireless ZIGBEE control solution (ACW) and simple movement detection solution (PIR). ;In the ACW version products, when the situation on the work floor changes, settings such as dimming levels and timing can be changed wirelessly by the end-users themselves. Luminaires can be combined in groups across the layout, and re-zoning them does not require a hardware change, thus minimising commissioning costs. The system delivers savings over and above the actual efficiency of the LEDs and is future-proof.;In the PIR version products, when there has no movement detected after 15 minutes, the lighting will dimming down to 25% of the lumen output, which helps to maximum your energy saving in a simple way. ;Easy to understand, easy to design-in, and easy to use, GreenPerform Highbay G3 is a smart way to light up your business.

Product data

General Information			
Light source colour	865 cool daylight	Optical cover/lens type	PC [Polycarbonate bowl/cover]
Light source replaceable	No	Luminaire light beam spread	60°
Number of gear units	1 unit	Control interface	-
Driver/power unit/transformer	PSR [Power supply unit regulating]	Connection	Flying leads/wires
Driver included	Yes	Cable	Cable 3.0 m without plug (C3K)
Optic type	NB [Narrow beam]	Protection class IEC	Safety class I (I)
		Glow-wire test	650/5 [Temperature 650 °C, duration 5 s]

GreenPerform Highbay G3

Flammability mark	F [For mounting on normally flammable surfaces]
CE mark	CE mark
Warranty period	3 years
Constant light output	No
Number of products on MCB (16 A type B)	11
Light source engine type	LED

Operating and Electrical

Input Voltage	220 to 240 V
Input frequency	50 to 60 Hz
Inrush current	46 A
Inrush time	0.44 ms
Power factor (min.)	0.95

Controls and Dimming

Dimmable	Yes
----------	-----

Mechanical and Housing

Housing material	Aluminum die-cast
Optic material	Polycarbonate
Optical cover/lens material	Polycarbonate
Optical cover/lens finish	Clear
Overall height	107 mm
Overall diameter	452 mm
Colour	Dark gray

Approval and Application

Ingress protection code	IP65 [Dust penetration-protected, jet-proof]
Mech. impact protection code	IK07 [2 J reinforced]

Initial Performance (IEC Compliant)

Initial luminous flux	20000 lm
Luminous flux tolerance	+/-10%
Initial LED luminaire efficacy	129 lm/W
Init. Corr. Colour Temperature	6500 K
Init. Colour rendering index	>80
Initial chromaticity	(0.313.0.324)SDCM<5
Initial input power	155 W
Power consumption tolerance	+/-10%

Over Time Performance (IEC Compliant)

Median useful life L70B50	50000 h
Median useful life L80B50	40000 h
Median useful life L90B50	30000 h

Application Conditions

Ambient temperature range	-30 to +50 °C
Suitable for random switching	Yes

Product Data

Full product code	911401866399
Order product name	BY698X LED200/CW PIR NB L3000 EN
Order code	01866399
Numerator – quantity per pack	1
Numerator – packs per outer box	1
SAP material	911401866399
SAP net weight (piece)	5.099 kg



Dimensional drawing

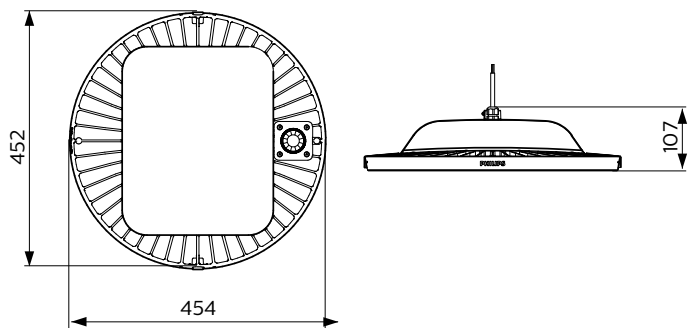

BY698P GreenPerform High-bay gen3

GreenPerform Highbay G3

