



ActiLume DALI

LRI1663/00 ActiLume gen2 Multi-Sensor

The Philips ActiLume lighting control system consists of a small, lightweight sensor and controller designed for easy integration into luminaires. ActiLume is a true plug & play solution for open-plan (up to 34 luminaires) or cell offices (e.g. 4 luminaires). Used in a master-and-slave luminaire concept, easy to use and easy to install. Specific application brochures are available to help specify and apply the system in an optimal way. Commissioning is optional for all application modes. Using this method, functions can be changed without affecting the electrical installation.

Product data

Product Data	
Full product code	871829168092500
Order product name	LRI1663/00 ActiLume gen2 Multi-Sensor
EAN/UPC – product	8718291680925
Order code	68092500
SAP numerator – quantity per pack	1
SAP numerator – packs per outer box	12
Material no. (12 NC)	913700356703
SAP net weight (piece)	28.000 g

ActiLume DALI

Dimensional drawing

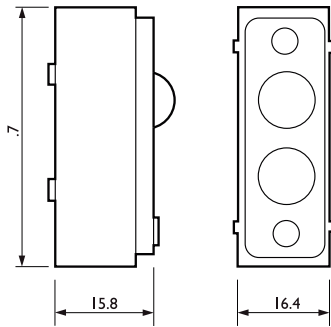

LRI1663/00 ActiLume gen2 Multi-Sensor

