



Dynalite Relay Controllers

DDRC810DT-GL

8 channel Relay Controller for any switched load up to 10A per channel, with a maximum box load of 40A.

8 channel Relay Controller for any switched load up to 10A per channel, with a maximum box load of 40A.

Product data

General Information	
CE mark	CE mark
Remarks	Please download the Lighting - Product Data Sheet for more information and ordering options
EU RoHS compliant	Yes
Application Conditions	
Ambient temperature range	0 to +50 °C
Product Data	
Full product code	871869600688700

Order product name	DDRC810DT-GL
EAN/UPC – product	8718696006887
Order code	00688700
SAP numerator – quantity per pack	1
Numerator – packs per outer box	1
SAP material	913703035209
SAP net weight (piece)	490.000 g

Dynalite Relay Controllers

Dimensional drawing

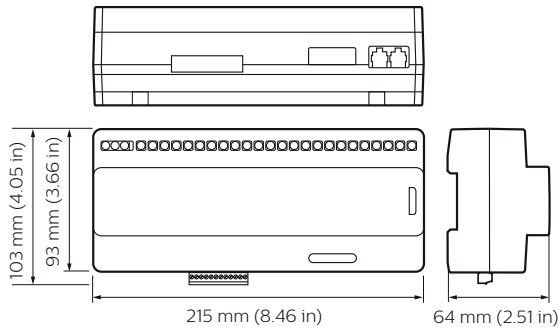

Dynalite Relay Controllers

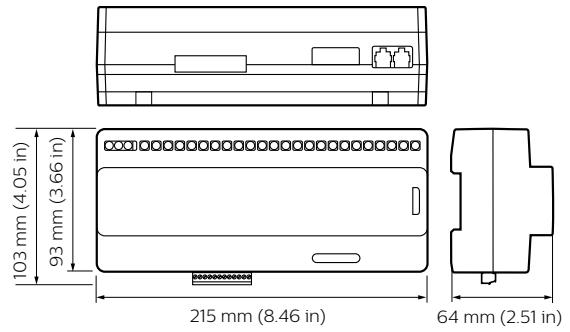

Dynalite Relay Controllers

