



Dynalite Relay Controllers

DMRC210

2 channel compact Relay Controller

2 channel compact Relay Controller

Product data

General Information	
CE mark	CE mark
Remarks	Please download the Lighting - Product Data Sheet for more information and ordering options
EU RoHS compliant	Yes
Application Conditions	
Ambient temperature range	0 to +50 °C
Product Data	
Full product code	871016350688300

Order product name	DMRC210
EAN/UPC – product	8710163506883
Order code	50688300
SAP numerator – quantity per pack	1
Numerator – packs per outer box	1
SAP material	913703050009
SAP net weight (piece)	0.700 kg

Dynalite Relay Controllers

Dimensional drawing

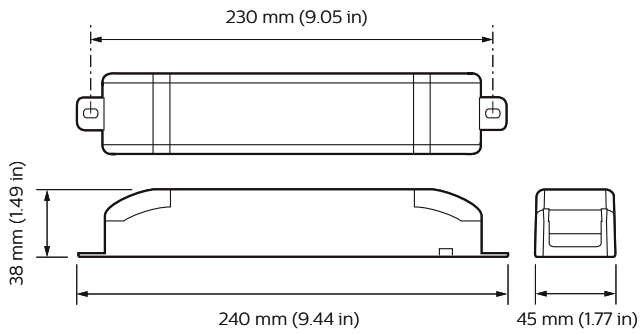

Dynalite Relay Controllers

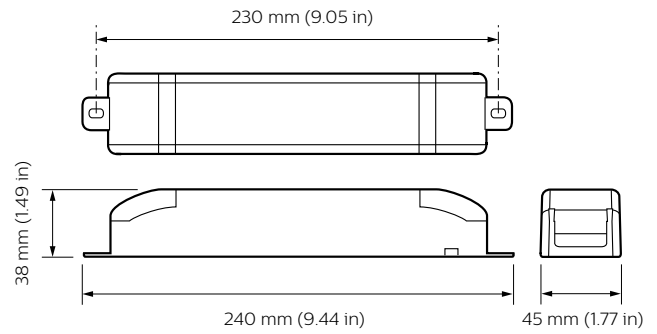

Dynalite Relay Controllers

