



Dynalite System Integration

DDNI485

Passive Gateway to provide cost-effective optical isolation

Passive Gateway to provide cost-effective optical isolation

Product data

General Information	
CE mark	CE mark
Remarks	Please download the Lighting - Product Data Sheet for more information and ordering options
EU RoHS compliant	Yes

Approval and Application	
IP classification	IP 20 [Ingress Protection 20]

Application Conditions	
Ambient temperature range	0 to +50 °C

Product Data	
Full product code	871016350788000
Order product name	DDNI485
EAN/UPC – product	8710163507880
Order code	50788000
SAP numerator – quantity per pack	1
Numerator – packs per outer box	1
SAP material	913703081309
SAP net weight (piece)	0.150 kg

Dynalite System Integration

Dimensional drawing



Dynalite System Integration

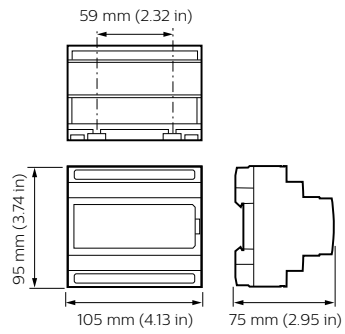

Dynalite System Integration

