



Dynalite Sensors

DUS90CS

Wall/ceiling mount 90° multifunction sensor

Wall/ceiling mount 90° multifunction sensor

Product data

General Information	
CE mark	CE mark
Remarks	Please download the Lighting - Product Data Sheet for more information and ordering options
EU RoHS compliant	Yes
Application Conditions	
Ambient temperature range	-20 to +45 °C
Product Data	
Full product code	871869688807000

Order product name	DUS90CS
EAN/UPC – product	8718696888070
Order code	88807000
SAP numerator – quantity per pack	1
Numerator – packs per outer box	1
SAP material	913703244209
SAP net weight (piece)	214.000 g

Dynalite Sensors

Dimensional drawing

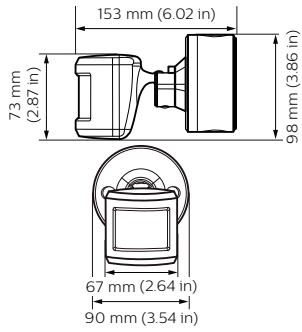

Dynalite Sensors

